

Basic Characteristics Data

| Model | Circuit method | Switching frequency [kHz] (reference) | Input current [A] | Inrush current protection | PCB/Pattern | | | Series/Parallel operation | |
|-------|-------------------|---------------------------------------|-------------------|---------------------------|-------------------------------|--------------|--------------|---------------------------|--------------------|
| | | | | | Material | Single sided | Double sided | Series operation | Parallel operation |
| MG15 | Flyback converter | 445-495 | *1 | - | glass fabric base,epoxy resin | | Yes | Yes | *2 |
| MGF15 | Flyback converter | 445-495 | *1 | - | glass fabric base,epoxy resin | | Yes | Yes | *2 |
| MG30 | Forward converter | 380-460 | *1 | - | glass fabric base,epoxy resin | | Yes | Yes | *2 |
| MGF30 | Forward converter | 380-460 | *1 | - | glass fabric base,epoxy resin | | Yes | Yes | *2 |

*1 Refer to Specification.

*2 Refer to the Instruction Manual.

1 Pin Configuration MG-20

2 Functions MG-20

- 2.1 Input Voltage Range MG-20
- 2.2 Overcurrent Protection MG-20
- 2.3 Overvoltage Protection MG-20
- 2.4 Isolation MG-21
- 2.5 Output Voltage Adjustment Range MG-21
- 2.6 Remote ON/OFF MG-21

3 Wiring to Input/Output Pin MG-21

- 3.1 Wiring input pin MG-21
- 3.2 Wiring output pin MG-22

4 Series/Parallel Operation MG-22

- 4.1 Series Operation MG-22
- 4.2 Redundancy Operation MG-23

5 Input Voltage/Current Range MG-23

6 Assembling and Installation MG-23

- 6.1 Installation MG-23
- 6.2 Hand Mounting MG-23
- 6.3 Soldering Conditions MG-23
- 6.4 Stress to Pin MG-23
- 6.5 Cleaning MG-23

7 Safety Standards MG-24

8 Derating MG-24

- 8.1 MG15/MGF15 Derating Curve MG-24
- 8.2 MG30/MGF30 Derating Curve MG-24

9 Peak Current (Pulse Load) MG-25

10 Using DC-DC Converters MG-26

11 Note to use $\pm 5V$ output MG-27

12 Lifetime expectancy depends on stress by temperature difference MG-27

- 12.1 MG15/MGF15 Lifetime expectancy depends on stress by temperature difference MG-27
- 12.2 MG30/MGF30 Lifetime expectancy depends on stress by temperature difference MG-27

1 Pin Configuration

Table 1.1 Pin Configuration and Functions (MG15)

| Pin No. | Pin Name | Function |
|---------|----------|--|
| ① | +Vin | +DC Input |
| ② | -Vin | -DC Input |
| ③ | RC | Remote ON/OFF |
| ④ | +Vout | +DC Output |
| ⑤ | TRM | Output Voltage Adjustment (please see 2.5) |
| | COM | GND of Output Voltage (for Dual Output) |
| ⑥ | -Vout | -DC Output |

●Single Output

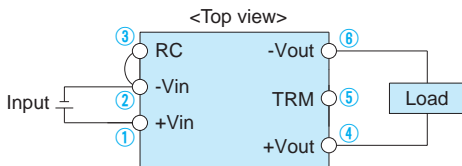

●Dual(±)Output

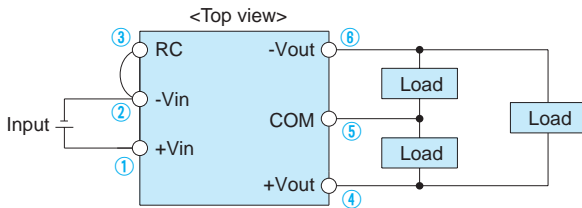
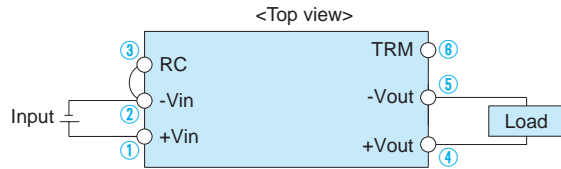

Fig.1.1 Pin Configuration (MG15)

Table 1.2 Pin Configuration and Functions (MG30)

| Pin No. | Pin Name | Function |
|---------|----------|--|
| ① | +Vin | +DC Input |
| ② | -Vin | -DC Input |
| ③ | RC | Remote ON/OFF |
| ④ | +Vout | +DC Output |
| ⑤ | -Vout | -DC Output (for Single Output) |
| | COM | GND of Output Voltage (for Dual Output) |
| ⑥ | TRM | Output Voltage Adjustment (please see 2.5) |
| | -Vout | -DC Output (for Dual Output) |

●Single Output



●Dual(±)Output

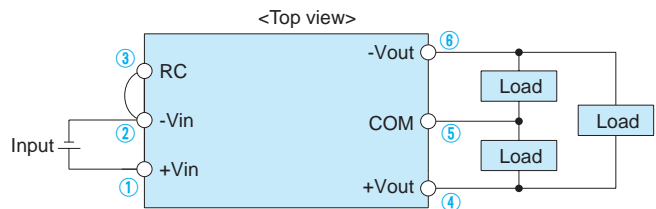

Fig.1.2 Pin Configuration (MG30)

2 Functions

2.1 Input Voltage Range

■ If output voltage value doesn't fall within specifications, a unit may not operate in accordance with specifications and/or fail.

2.2 Overcurrent Protection

■ Overcurrent Operation

An overcurrent protection circuit is built-in and activated at 105% of the rated current or above. It prevents the unit from short circuit and overcurrent for less than 20 seconds. The output voltage of the power supply will recover automatically if the fault causing over current is corrected.

When the output voltage drops after OCP works, the power supply enters a "hiccup mode" where it repeatedly turns on and off at a certain frequency.

2.3 Overvoltage Protection (Excluding MG15)

■ Over Voltage Protection (OVP) is built in. When OVP works, output voltage can be recovered by shutting down DC input for at least one second or by turning off the remote control switch for one second without shutting down the DC input. The recovery time varies according to input voltage and input capacitance.

Remarks :

Note that devices inside the power supply may fail when a voltage greater than the rated output voltage is applied from an external power supply to the output terminal of the power supply. This could happen in in-coming inspections that include OVP function test or when voltage is applied from the load circuit.

2.4 Isolation

When you run a Hi-Pot test as receiving inspection, gradually increase the voltage to start. When you shut down, decrease the voltage gradually by using a dial. Please avoid a Hi-Pot tester with a timer because, when the timer is turned ON or OFF, it may generate a voltage a few times higher than the applied voltage.

2.5 Output Voltage Adjustment Range(MGS/MGFS Only)

- The output voltage is adjustable through an external potentiometer. Adjust only within the range of $\pm 10\%$ of the rated voltage.
- To increase the output voltage, turn the potentiometer clockwise and connect in such a way that the resistance value between 2 and 3 becomes small. To decrease the output voltage, turn the potentiometer counter-clockwise.
- Please use a wire as short as possible to connect to the potentiometer and connect it from the pin on the power supply side. Temperature coefficient deteriorates when some types of resistors and potentiometers are used. Please use the following types.
 Resistor..... Metal Film Type, Temperature Coefficient of $t100\text{ppm/C}$ or below
 Potentiometer... Cermet Type, Temperature Coefficient of $t300\text{ppm/C}$ or below
- If output voltage adjustment is not required, open the TRM pin.
- Output voltage adjustment may increase to overvoltage protection activation range based on determined external resistor values.

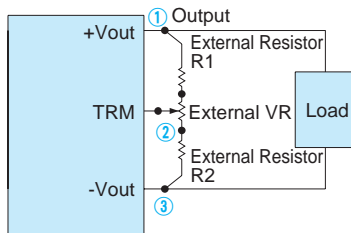

Fig.2.1 Connecting External Devices

Table 2.1 List of External Devices

| Item # | Output Voltage | Constant of External Device [Ω] (Adjustable within $\pm 10\%$) | | |
|--------|----------------|---|-----|------|
| | | VR | R1 | R2 |
| 1 | 3.3V | 1k | 100 | 100 |
| 2 | 5V | 1k | 100 | 270 |
| 3 | 12V | 5k | 10k | 1.5k |
| 4 | 15V | 5k | 10k | 1k |
| 5 | $\pm 5V$ | | | |
| 6 | $\pm 12V$ | | | |
| 7 | $\pm 15V$ | | | |

2.6 Remote ON/OFF

The remote ON/OFF function is incorporated in the input circuit and operated with RC and -Vin. If positive logic control is required, order the power supply with “-R” option.

Table 2.2 Remote ON/OFF Specifications

| | ON/OFF logic | Between RC and -Vin | Output voltage |
|-------------|--------------|-----------------------------|----------------|
| Standard | Negative | L level (0 - 1.2V) or short | ON |
| | | H level (3 - 12V) or open | OFF |
| Optional -R | Positive | L level (0 - 1.2V) or short | OFF |
| | | H level (3 - 12V) or open | ON |

- When RC is at low level, a current of 0.5mA typ will flow out.
- When remote ON/OFF is not used, short RC and -Vin.

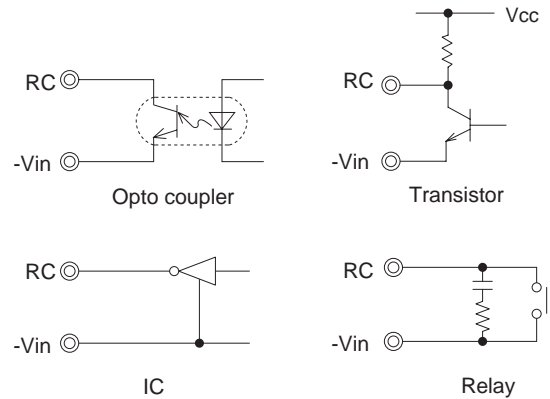

Fig.2.2 RC Connection Example

3 Wiring to Input/Output Pin

3.1 Wiring input pin

- MG series has Pi-shaped filter internally. You can add a capacitor C_i near the input pin terminal and reduce reflected input noise from the converter. Please connect the capacitor as needed.
- When you use a capacitor C_i , please use the one with high frequency and good temperature characteristics.
- If the power supply is to be turned ON/OFF directly with a switch, inductance from the input line will induce a surge voltage several times that of the input voltage and it may damage the power supply. Make sure that the surge is absorbed, for example, by connecting an electrolytic capacitor between the input pins.

■ If an external filter containing L (inductance) is added to the input line or a wire from the input source to the MG series is long, not only the reflected input noise becomes large, but also the output of the converter may become unstable. In such case, connecting C_i to the input pin is recommended.

■ If you use an aluminum electrolytic capacitor, please pay attention to the ripple current rating.

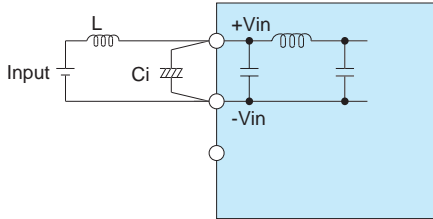

Fig.3.1 Connecting an External Capacitor to the Input Side

 Table 3.1 Recommended Capacitance of an External Capacitor on the Input Side [μF]

| Model Input Voltage[V] | MG15 | MG30 |
|---------------------------|------|------|
| 12 | 220 | 220 |
| 24 | 100 | 100 |
| 48 | 47 | 47 |
| 12 - 24 | 100 | 100 |
| 24 - 48 | 47 | 47 |

* Please adjust the capacitance in accordance with a degree of the effect you want to achieve.

■ If a reverse polarity voltage is applied to the input pin, the power supply will fail.

If there is a possibility that a reverse polarity voltage is applied, connect a protection circuit externally as described below.

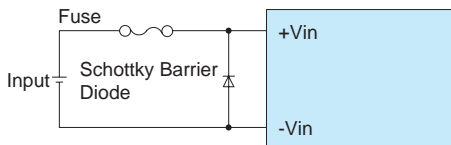

Fig.3.2 Connecting a Reverse Voltage Protection Circuit

3.2 Wiring output pin

■ If you want to further reduce the output ripple noise, connect an electrolytic capacitor or a ceramic capacitor C_o to the output pin as shown below.

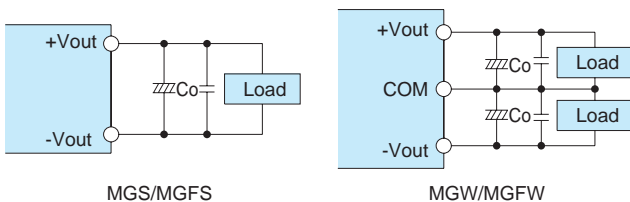

Fig.3.3 Connecting Example of an External Capacitor to the Output Side

 Table 3.2 Recommended Capacitance of External Capacitor on the Output Side [μF]

| Model Output Voltage[V] | MG15 | MG30 |
|----------------------------|------|------|
| 3.3 | 470 | 470 |
| 5 | 470 | 470 |
| 12 | 150 | 150 |
| 15 | 100 | 100 |
| ± 5 | 330 | 330 |
| ± 12 | 100 | 100 |
| ± 15 | 47 | 47 |

* If you use a ceramic capacitor, keep the capacitance within the range between about 0.1 to 22 μF .

* Please adjust the capacitance in light of the effect you want to achieve.

* If you need to use an unproven external capacitor which capacitance moreover the range provided in Table 3.2, please contact us for the assistance.

■ If the distance between the output and the load is long and therefore the noise is generated on the load side, connect a capacitor externally to the load as shown below.

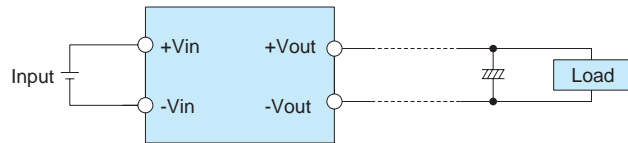

Fig.3.4 Connecting Example

4 Series/Parallel Operation

4.1 Series Operation

■ You can use the power supplies in series operation by wiring as shown below. In the case of (a) below, the output current should be lower than the rated current for each power supply with the lowest rated current among power supplies that are serially connected. Please make sure that no current exceeding the rated current flows into a power supply.

(a)

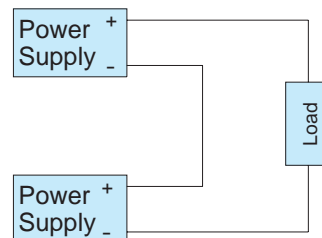

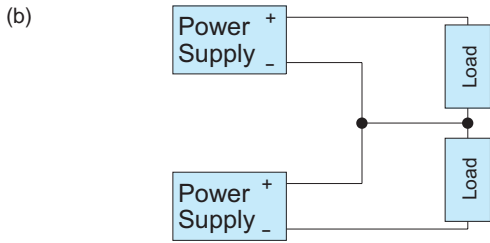

Fig.4.1 Series Operation

4.2 Redundancy Operation

■ You can use the power supplies in redundancy operation by wiring as shown below.

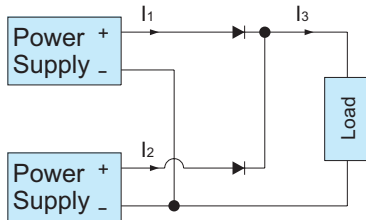

Fig.4.2 Redundancy Operation

■ Even a slight difference in output voltage can affect the balance between the values of I_1 and I_2 .

Please make sure that the value of I_3 does not exceed the rated current for each power supply.

$$I_3 \leq \text{Rated Current Value}$$

5 Input Voltage/ Current Range

■ If you use a non-regulated power source for input, please check and make sure that its voltage fluctuation range and ripple voltage do not exceed the input voltage range shown in specifications.

■ Please select an input power source with enough capacity, taking into consideration of the start-up current (I_p), which flows when a DC-DC converter starts up.

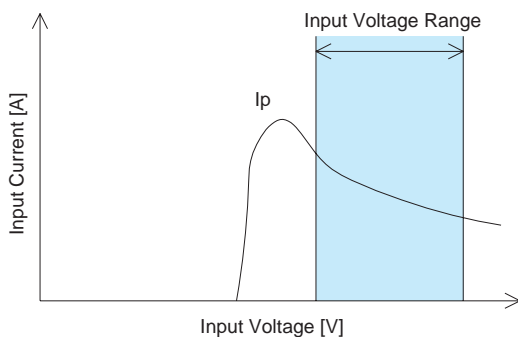

Fig.5.1 Input Current Characteristics

6 Assembling and Installation

6.1 Installation

■ When two or more power supplies are used side by side, position them with proper intervals to allow enough air ventilation. Ambient temperature around each power supply should not exceed the temperature range shown in derating curve.

6.2 Hand Mounting

■ Due to prevent failure, PS should not be pull after soldering with PCB.

6.3 Soldering Conditions

- (1) Flow Soldering : 260°C 15 seconds or less
- (2) Soldering Iron : maximum 360°C 5 seconds or less

6.4 Stress to Pin

■ Applying excessive stress to the input or output pins of the power module may damage internal connections. Avoid applying stress in excess of that shown in Fig. 6.1.

■ Input/output pin are soldered to the PCB internally. Do not pull or bend a lead powerfully.

■ If it is expected that stress is applied to the input/output pin due to vibration or impact, reduce the stress to the pin by taking such measures as fixing the unit to the PCB by silicone rubber, etc.

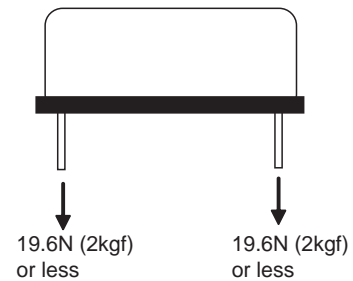

Fig.6.1 Stress onto Pins

6.5 Cleaning

■ If you need to clean the unit, please clean it under the following conditions.

Cleaning Method: Varnishing, Ultrasonic or Vapor Cleaning

Cleaning agent: IPA (Solvent type)

Cleaning Time: Within total 2 minutes for varnishing, ultrasonic and vapor cleaning

■ Please dry the unit sufficiently after cleaning.

■ If you do ultrasonic cleaning, please keep the ultrasonic output at 15W/l or below.

7 Safety Standards

- To apply for a safety standard approval using the power supply, please meet the following conditions. Please contact us for details.
- Please use the unit as a component of an end device.
- The area between the input and the output of the unit is isolated functionally. Depending upon the input voltage, basic insulation, dual insulation or enhanced insulation may be needed. In such case, please take care of it within the structure of your end-device. Please contact us for details.

8 Derating

8.1 MG15 / MGF15 Derating Curve

■ If you derate the output current, you can use the unit in the temperature range from -40°C to the maximum temperature shown below.

(1) In the case of Convection Cooling

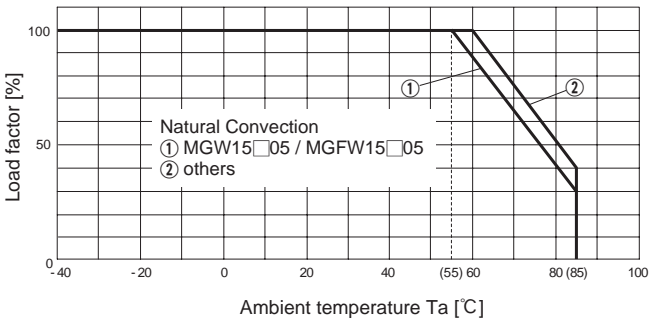

Fig.8.1 Derating Curve for Convection Cooling (Rated Input Voltage)

(2) In the case of Forced Air Cooling (1.0m/s)(Excluding MGW15□05/MGFW15□05)

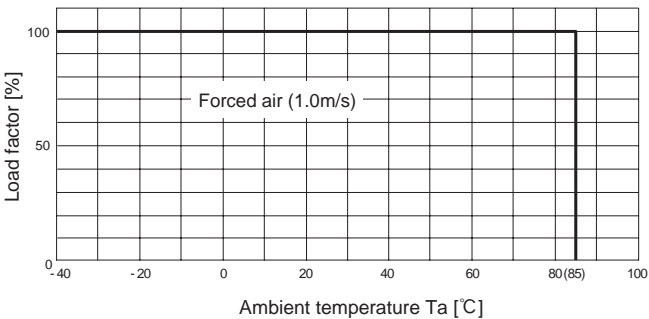

Fig.8.2 Derating Curve for Forced Air Cooling (1.0m/s) (Rated Input Voltage)

(3) In the case of Forced Air Cooling (1.0m/s, 2.5m/s)(MGW15□05/MGFW15□05)

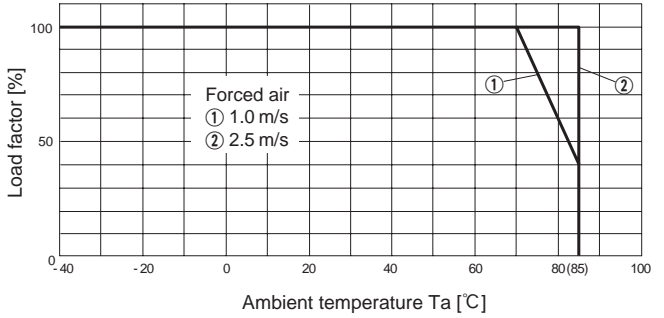

Fig.8.3 Derating Curve for Forced Air Cooling (1.0m/s,2.5m/s) (Rated Input Voltage)

(4) Temperature Measuring Point on the case.

■ In case of forced air cooling, please have sufficient ventilation to keep the temperature of point A in Fig.8.4 at 105°C or below.

Please also make sure that the ambient temperature does not exceed 85°C.

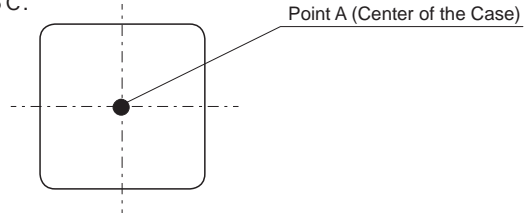

Fig.8.4 Temperature Measuring Point on the case (Top View)

8.2 MG30 / MGF30 Derating Curve

■ If you derate the output current, you can use the unit in the temperature range from -40°C to the maximum temperature shown below.

(1) In the case of Convection Cooling

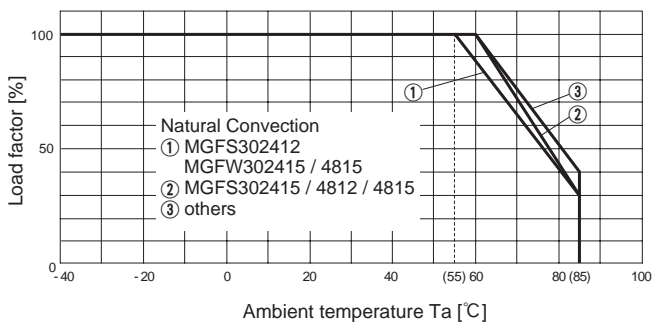

Fig.8.5 Derating Curve for Convection Cooling (Rated Input Voltage)

(2) In the case of Forced Air Cooling (1.0m/s)(Excluding MGW30□05 and MGFW30□12/15)

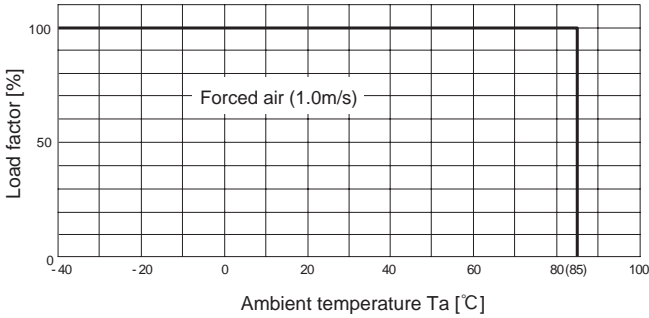

Fig.8.6 Derating Curve for Forced Air Cooling (1.0m/s) (Rated Input Voltage)

(3) In the case of Forced Air Cooling (1.0m/s, 1.5m/s)(MGW30□05 and MGFW30□12/15)

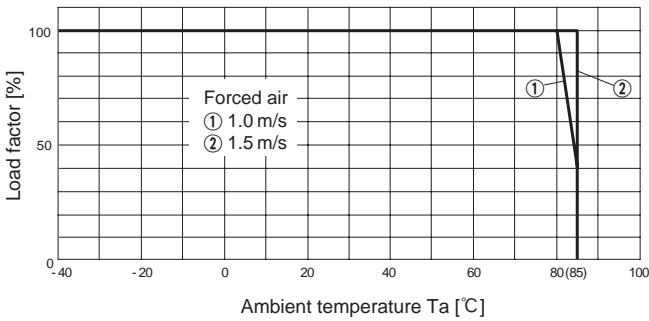

Fig.8.7 Derating Curve for Forced Air Cooling (1.0m/s,1.5m/s) (Rated Input Voltage)

(4) Temperature Measuring Point on the case.

■In case of forced air cooling, please have sufficient ventilation to keep the temperature of point A in Fig.8.8 at 110°C or below.

Please also make sure that the ambient temperature does not exceed 85°C.

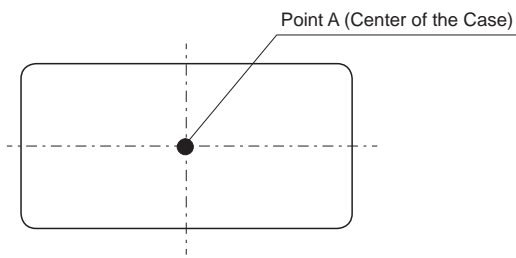
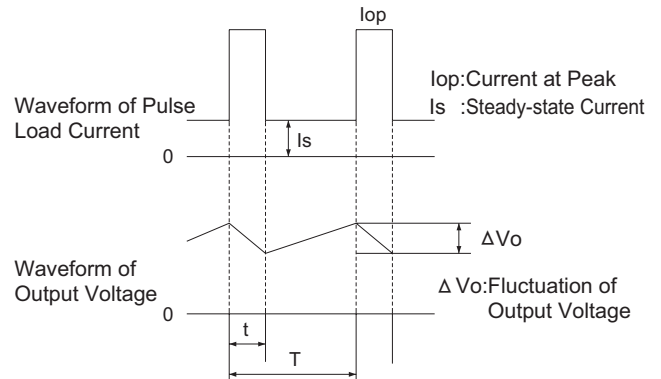
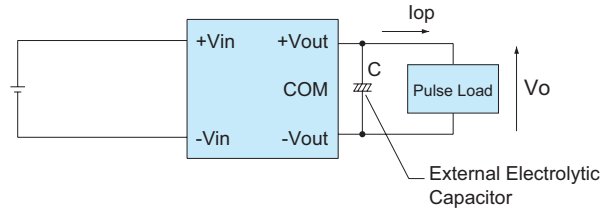

Fig.8.8 Temperature Measuring Point on the case (Top View)

9 Peak Current (Pulse Load)

■If a load connected to a converter is a pulse load, you can provide a pulse current by connecting an electrolytic capacitor externally to the output side.



■The average output current I_{lav} is expressed in the following formula.

$$I_{lav} = I_s + \frac{(I_{op} - I_s) \times t}{T}$$

■Required electrolytic capacitor C can be obtained from the following formula.

$$C = \frac{(I_{op} - I_{lav}) \times t}{\Delta V_o}$$

10 Using DC-DC Converters

■ When using AC power source

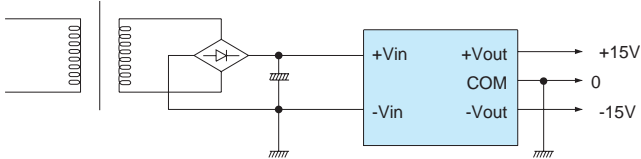

■ When using a battery-operated device

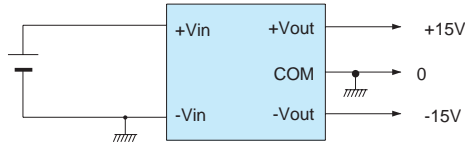

■ When a floating mechanism is required for the output circuit

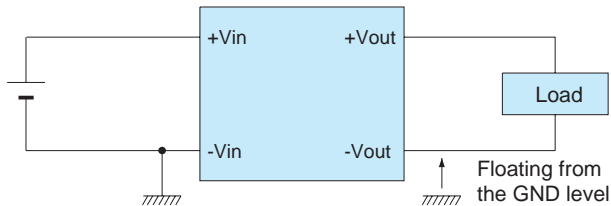

■ To draw a reverse polarity output

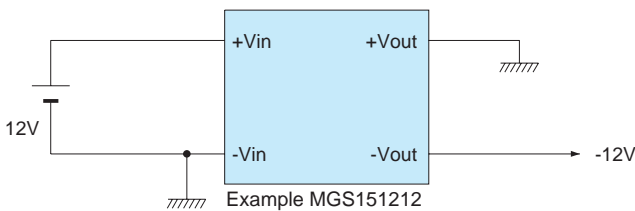

■ To provide a negative voltage to -Vin by using +Vin side of the converter as GND potential (0V)

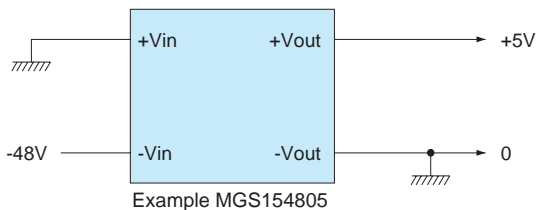

■ To draw the sum of input voltage and plus output voltage

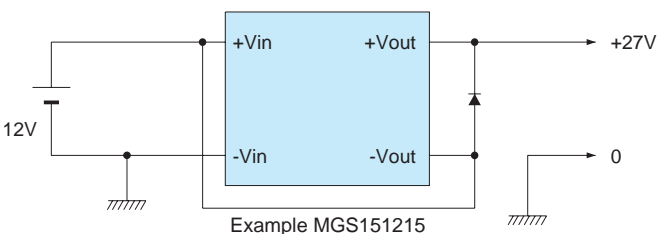

* Output current should be the same as the rated output current of the converter.

* Output current fluctuation is the sum of the input voltage fluctuation and the output voltage fluctuation of the converter.

■ To use a dual output type

* Dual output type is typically used in the following manner.

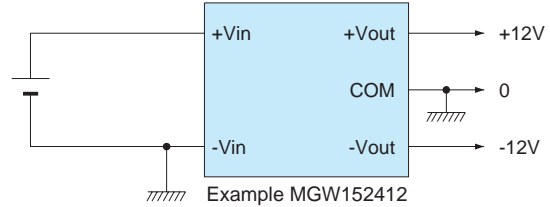

* The unit can be used as a 24V type single output power supply as follows.

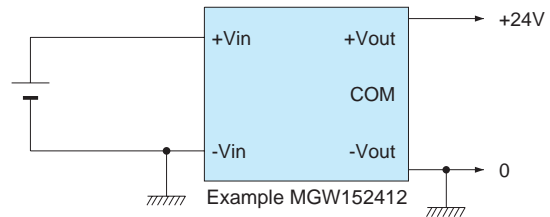

* Another way to use the unit is described below.

* The sum of +12V and +24V flows to the 0V line. Please make sure that this value does not exceed the rated output current of the converter.

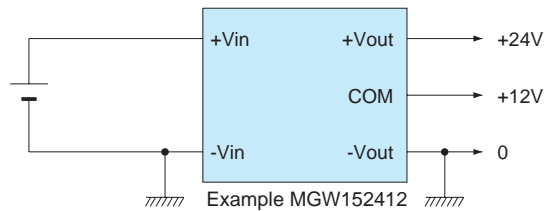

■ To draw 48V output

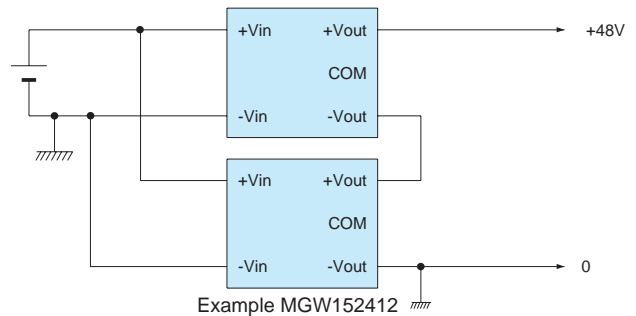

11 Note to use $\pm 5V$ output

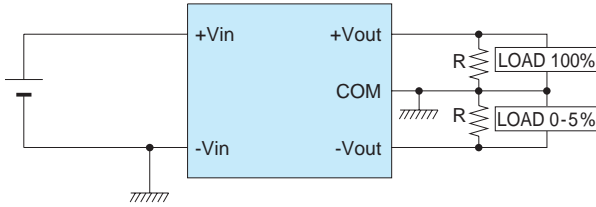

Fig.11.1 Example of decreasing the fluctuation of output voltage.

- If an output current is 0% to 5% of the rated current, the output is influenced by the other output load condition. 20% output voltage fluctuation may occur. To avoid the fluctuation, external bleeding resistor is required to draw sufficient current.

12 Lifetime expectancy depends on stress by temperature difference

- Regarding lifetime expectancy design of solder joint, following contents must be considered. It must be careful that the soldering joint is stressed by temperature rise and down which is occurred by self-heating and ambient temperature change. The stress is accelerated by thermal-cycling, therefore the temperature difference should be minimized as much as possible if temperature rise and down is occurred frequently.

12.1 MG15 / MGF15 Lifetime expectancy depends on stress by temperature difference

- Product lifetime expectancy depends on case temperature difference (ΔT_c) and number of cycling in a day is shown in Fig.12.1 (It is calculated based on our accelerated process test result.) If case temperature changes frequently by changing output load factor etc., the above the lifetime expectancy design should be applied as well. And point A which is shown in Fig.12.2 must keep below 105°C.

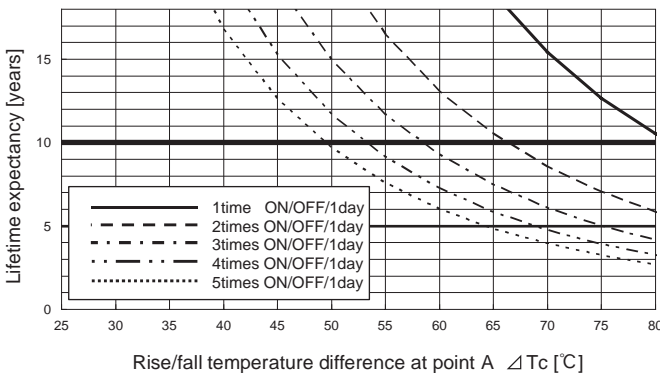

Fig.12.1 Lifetime expectancy against rise/fall temperature difference

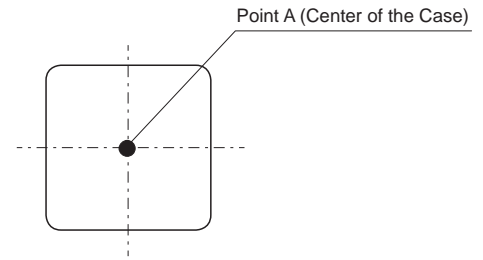

Fig.12.2 Temperature measuring point (Top View)

- The warranty period is basically 10 years, however it depends on the lifetime expectancy which is shown in Fig.12.1 if it is less than 10 years.

12.2 MG30 / MGF30 Lifetime expectancy depends on stress by temperature difference

- Product lifetime expectancy depends on case temperature difference (ΔT_c) and number of cycling in a day is shown in Fig.12.3 (It is calculated based on our accelerated process test result.) If case temperature changes frequently by changing output load factor etc., the above the lifetime expectancy design should be applied as well. And point A which is shown in Fig.12.4 must keep below 110°C.

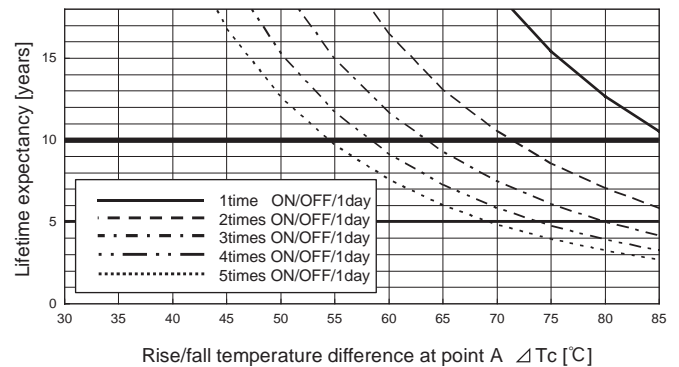

Fig.12.3 Lifetime expectancy against rise/fall temperature difference

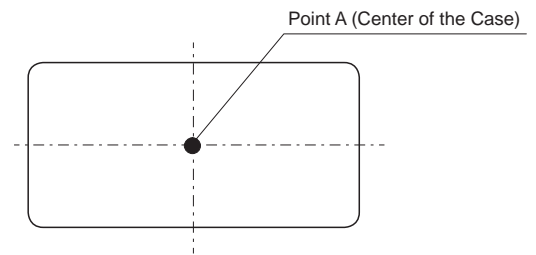

Fig.12.4 Temperature measuring point (Top View)

- The warranty period is basically 10 years, however it depends on the lifetime expectancy which is shown in Fig.12.3 if it is less than 10 years.